

# Figure 1: A differential via

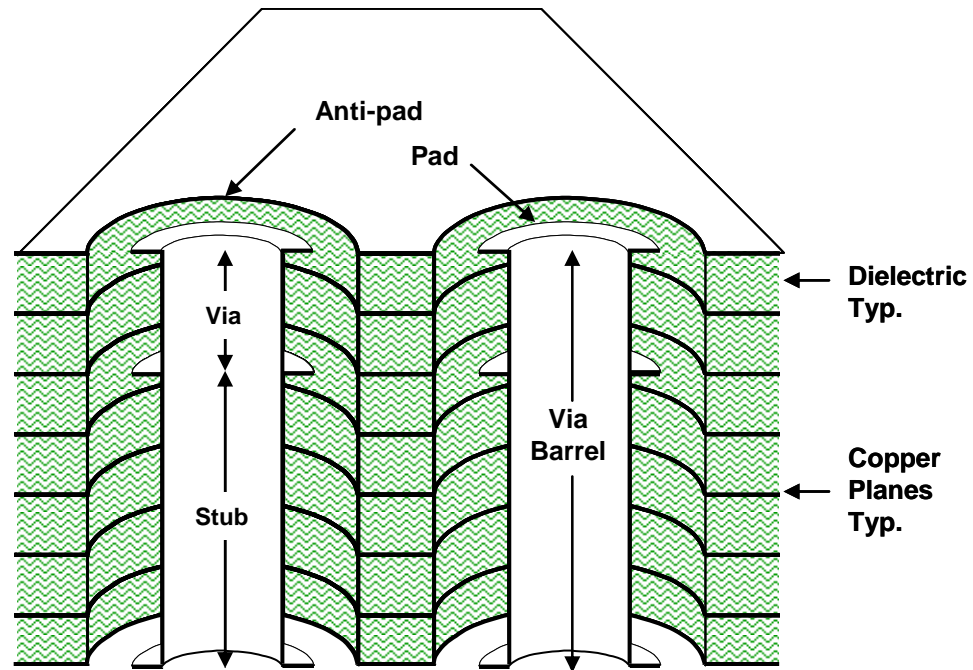

# Fig 2

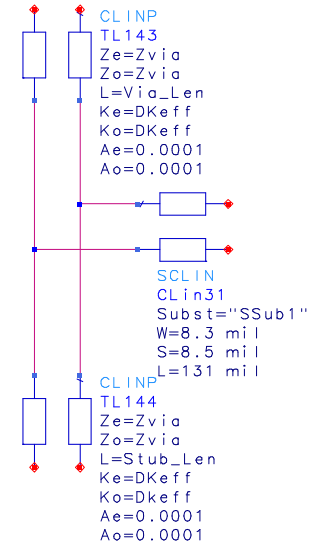
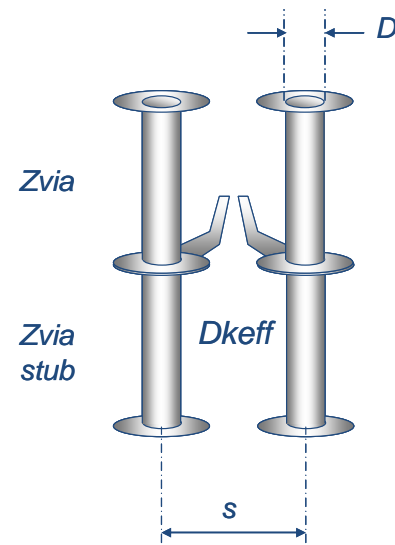

# Fig 3

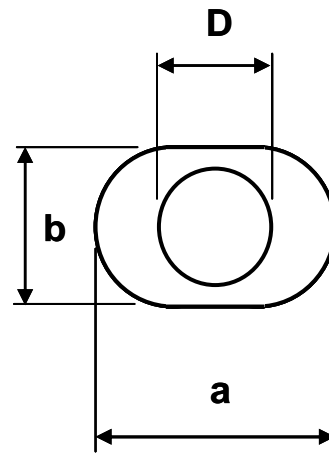

# Fig 4

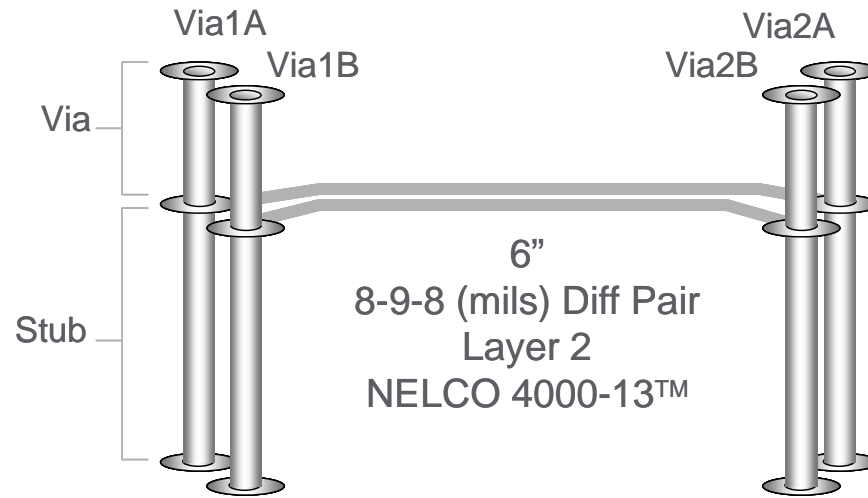

# Fig 5

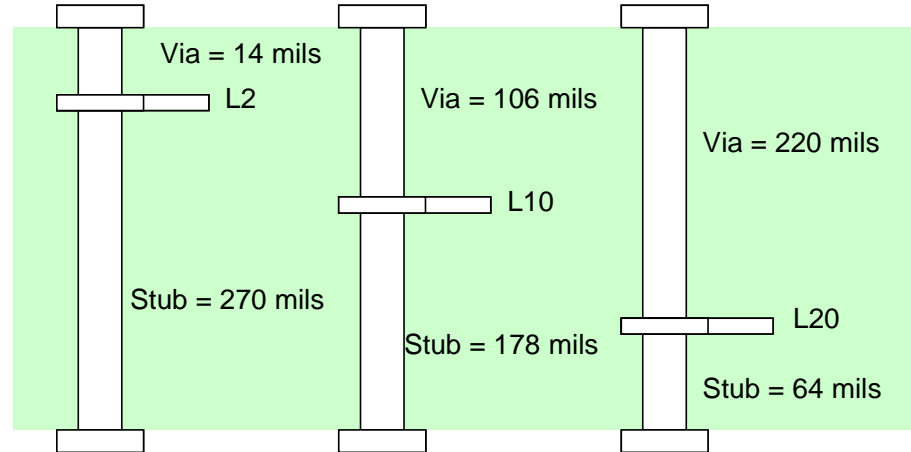

# Fig 6

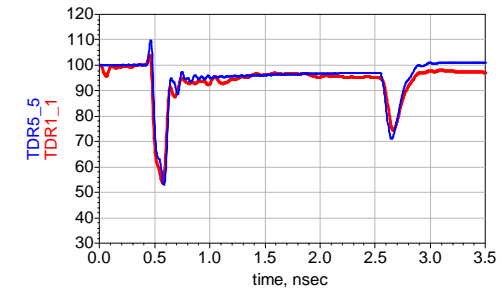
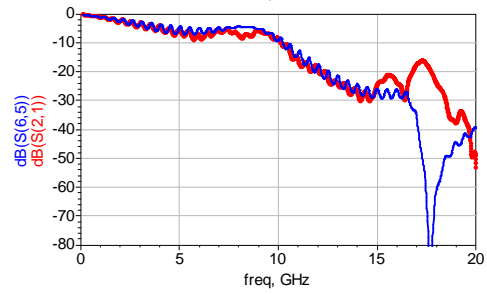
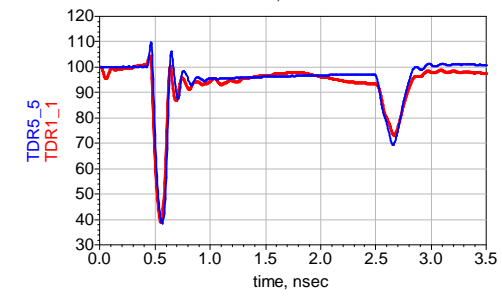
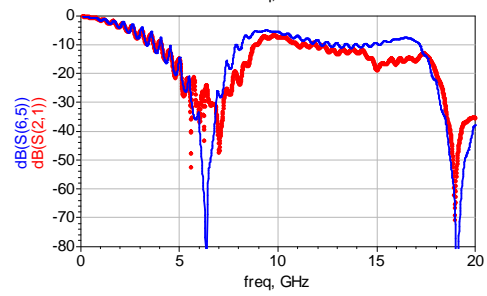
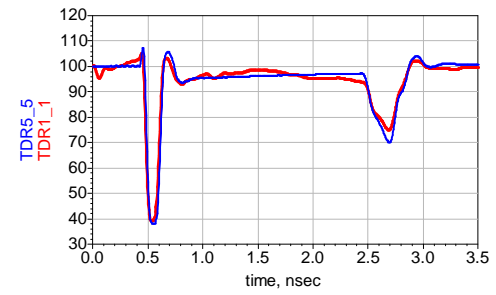
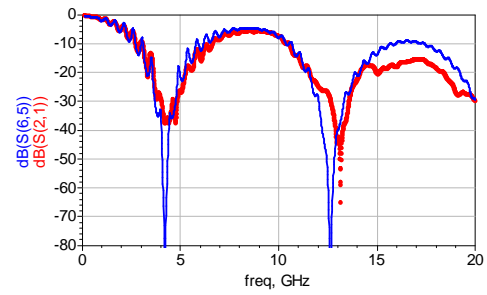

# Fig 7

